

### FEATURES

- Complete rate gyroscope on a single chip
- Z-axis (yaw rate) response
- High vibration rejection over wide frequency
- 2000 g powered shock survivability
- Ratiometric to referenced supply
- 5 V single-supply operation
- 105°C operation
- Self-test on digital command
- Ultrasmall and light: <0.15 cc, <0.5 gram
- Temperature sensor output
- RoHS compliant

### APPLICATIONS

- Vehicle chassis rollover sensing
- Inertial measurement units
- Platform stabilization

### GENERAL DESCRIPTION

The ADXRS622 is a complete angular rate sensor (gyroscope) that uses the Analog Devices, Inc., surface-micromachining process to make a functionally complete and low cost angular rate sensor integrated with all of the required electronics on one chip. The manufacturing technique for this device is the same high volume BiMOS process used for high reliability automotive airbag accelerometers.

The output signal, RATEOUT (1B, 2A), is a voltage proportional to the angular rate about the axis that is normal to the top surface of the package. The output is ratiometric with respect to a provided reference supply. An external capacitor sets the bandwidth. Other external capacitors are required for operation.

A temperature output is provided for compensation techniques. Two digital self-test inputs electromechanically excite the sensor to test proper operation of both the sensor and the signal conditioning circuits. The ADXRS622 is available in a 7 mm × 7 mm × 3 mm BGA chip-scale package.

### FUNCTIONAL BLOCK DIAGRAM

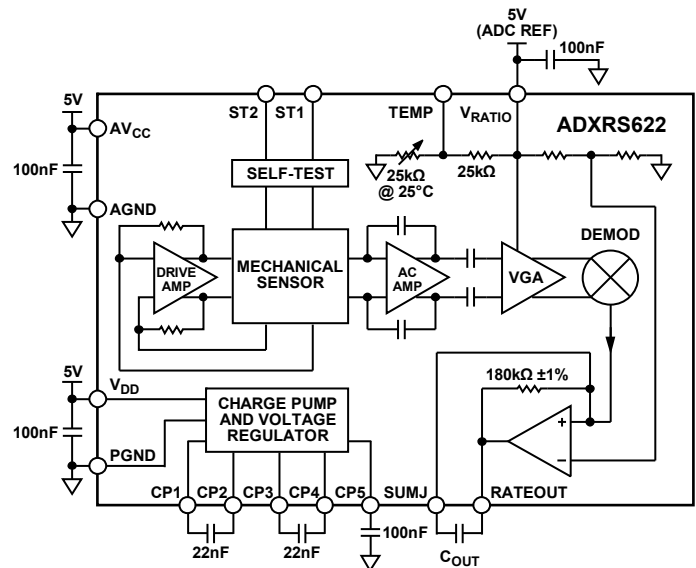

Figure 1.

### Rev. 0

Information furnished by Analog Devices is believed to be accurate and reliable. However, no responsibility is assumed by Analog Devices for its use, nor for any infringements of patents or other rights of third parties that may result from its use. Specifications subject to change without notice. No license is granted by implication or otherwise under any patent or patent rights of Analog Devices. Trademarks and registered trademarks are the property of their respective owners.

## TABLE OF CONTENTS

Features .....	1	Theory of Operation .....	9
Applications.....	1	Setting Bandwidth.....	9
General Description .....	1	Temperature Output and Calibration.....	9
Functional Block Diagram .....	1	Calibrated Performance.....	9
Revision History .....	2	ADXRS622 and Supply Ratiometricity .....	10
Specifications.....	3	Null Adjustment .....	10
Absolute Maximum Ratings.....	4	Self-Test Function .....	10
Rate Sensitive Axis .....	4	Continuous Self-Test.....	10
ESD Caution.....	4	Outline Dimensions .....	11
Pin Configuration and Function Descriptions.....	5	Ordering Guide .....	11
Typical Performance Characteristics .....	6		

## REVISION HISTORY

1/09 — Revision 0: Initial Version

## SPECIFICATIONS

All minimum and maximum specifications are guaranteed. Typical specifications are not guaranteed.

$T_A = -40^{\circ}\text{C}$  to  $+105^{\circ}\text{C}$ ,  $V_S = AV_{CC} = V_{DD} = 5\text{ V}$ ,  $V_{RATIO} = AV_{CC}$ , angular rate =  $0^{\circ}/\text{sec}$ , bandwidth = 80 Hz ( $C_{OUT} = 0.01\ \mu\text{F}$ ),  $I_{OUT} = 100\ \mu\text{A}$ ,  $\pm 1\text{ g}$ , unless otherwise noted.

**Table 1.**

Parameter	Conditions	Min	Typ	Max	Unit
SENSITIVITY <sup>1</sup>	Clockwise rotation is positive output				
Measurement Range <sup>2</sup>	Full-scale range over specifications range	$\pm 250$	$\pm 300$		$^{\circ}/\text{sec}$
Initial and Over Temperature	$-40^{\circ}\text{C}$ to $+105^{\circ}\text{C}$	6.2	7.0	7.8	$\text{mV}/^{\circ}\text{sec}$
Temperature Drift <sup>3</sup>			$\pm 2$		%
Nonlinearity	Best fit straight line		0.1		% of FS
NULL <sup>1</sup>					
Null	$-40^{\circ}\text{C}$ to $+105^{\circ}\text{C}$	2.15	2.5	2.85	V
Linear Acceleration Effect	Any axis		0.1		$^{\circ}/\text{sec}/\text{g}$
NOISE PERFORMANCE					
Rate Noise Density	$T_A \leq 25^{\circ}\text{C}$		0.06		$^{\circ}/\text{sec}/\sqrt{\text{Hz}}$
FREQUENCY RESPONSE					
Bandwidth <sup>4</sup>		0.01		2500	Hz
Sensor Resonant Frequency		12	14.5	17	kHz
SELF-TEST <sup>1</sup>					
ST1 RATEOUT Response	ST1 pin from Logic 0 to Logic 1	$-750$	$-525$	$-300$	mV
ST2 RATEOUT Response	ST2 pin from Logic 0 to Logic 1	300	525	750	mV
ST1 to ST2 Mismatch <sup>5</sup>		$-5$		$+5$	%
Logic 1 Input Voltage		3.3			V
Logic 0 Input Voltage				1.7	V
Input Impedance	To common	40	50	100	k $\Omega$
TEMPERATURE SENSOR <sup>1</sup>					
$V_{OUT}$ at $25^{\circ}\text{C}$	Load = 10 M $\Omega$	2.35	2.5	2.65	V
Scale Factor <sup>6</sup>	@ $25^{\circ}\text{C}$ , $V_{RATIO} = 5\text{ V}$		9		$\text{mV}/^{\circ}\text{C}$
Load to $V_S$			25		k $\Omega$
Load to Common			25		k $\Omega$
TURN-ON TIME	Power on to $\pm 1/2^{\circ}/\text{sec}$ of final			50	ms
OUTPUT DRIVE CAPABILITY					
Current Drive	For rated specifications			200	$\mu\text{A}$
Capacitive Load Drive				1000	pF
POWER SUPPLY					
Operating Voltage ( $V_S$ )		4.75	5.00	5.25	V
Quiescent Supply Current			3.5	4.5	mA
TEMPERATURE RANGE					
Specified Performance		$-40$		$+105$	$^{\circ}\text{C}$

<sup>1</sup> Parameter is linearly ratiometric with  $V_{RATIO}$ .

<sup>2</sup> Measurement range is the maximum range possible, including output swing range, initial offset, sensitivity, offset drift, and sensitivity drift at 5 V supplies.

<sup>3</sup> From  $+25^{\circ}\text{C}$  to  $-40^{\circ}\text{C}$  or  $+25^{\circ}\text{C}$  to  $+105^{\circ}\text{C}$ .

<sup>4</sup> Adjusted by external capacitor,  $C_{OUT}$ . Reducing bandwidth below 0.01 Hz does not result in further noise improvement.

<sup>5</sup> Self-test mismatch is described as  $(ST2 + ST1)/((ST2 - ST1)/2)$ .

<sup>6</sup> Scale factor for a change in temperature from  $25^{\circ}\text{C}$  to  $26^{\circ}\text{C}$ .  $V_{TEMP}$  is ratiometric to  $V_{RATIO}$ . See the Temperature Output and Calibration section for more information.

# ADXRS622

## ABSOLUTE MAXIMUM RATINGS

Table 2.

Parameter	Rating
Acceleration (Any Axis, 0.5 ms)	
Unpowered	2000 g
Powered	2000 g
$V_{DD}$ , $AV_{CC}$	-0.3 V to +6.0 V
$V_{RATIO}$	$AV_{CC}$
ST1, ST2	$AV_{CC}$
Output Short-Circuit Duration (Any Pin to Common)	Indefinite
Operating Temperature Range	-55°C to +125°C
Storage Temperature Range	-65°C to +150°C

Stresses above those listed under the Absolute Maximum Ratings may cause permanent damage to the device. This is a stress rating only; functional operation of the device at these or any other conditions above those indicated in the operational section of this specification is not implied. Exposure to absolute maximum rating conditions for extended periods may affect device reliability.

Drops onto hard surfaces can cause shocks of >2000 g and can exceed the absolute maximum rating of the device. Exercise care during handling to avoid damage.

### RATE SENSITIVE AXIS

The ADXRS622 is a Z-axis rate-sensing device (also called a yaw rate-sensing device). It produces a positive going output voltage for clockwise rotation about the axis normal to the package top, that is, clockwise when looking down at the package lid.

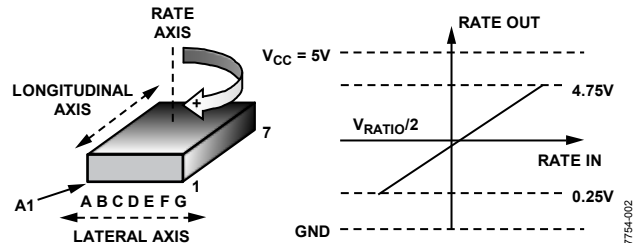

Figure 2. RATEOUT Signal Increases with Clockwise Rotation

### ESD CAUTION



**ESD (electrostatic discharge) sensitive device.** Charged devices and circuit boards can discharge without detection. Although this product features patented or proprietary protection circuitry, damage may occur on devices subjected to high energy ESD. Therefore, proper ESD precautions should be taken to avoid performance degradation or loss of functionality.

## PIN CONFIGURATION AND FUNCTION DESCRIPTIONS

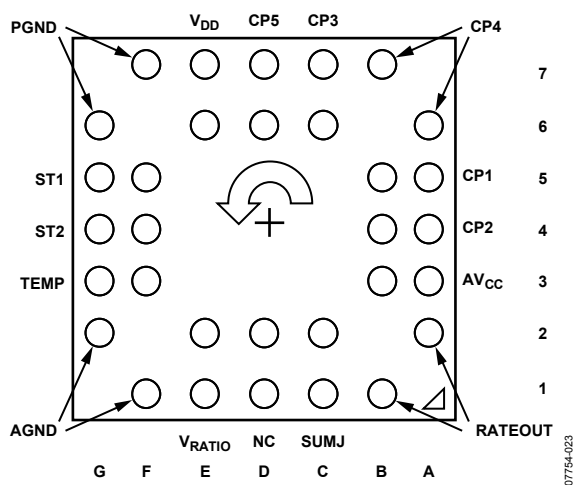

Figure 3. Pin Configuration

Table 3. Pin Function Descriptions

Pin No.	Mnemonic	Description
6D, 7D	CP5	HV Filter Capacitor (0.1 $\mu$ F).
6A, 7B	CP4	Charge Pump Capacitor (22 nF).
6C, 7C	CP3	Charge Pump Capacitor (22 nF).
5A, 5B	CP1	Charge Pump Capacitor (22 nF).
4A, 4B	CP2	Charge Pump Capacitor (22 nF).
3A, 3B	AV <sub>CC</sub>	Positive Analog Supply.
1B, 2A	RATEOUT	Rate Signal Output.
1C, 2C	SUMJ	Output Amp Summing Junction.
1D, 2D	NC	No Connect.
1E, 2E	V <sub>RATIO</sub>	Reference Supply for Ratiometric Output.
1F, 2G	AGND	Analog Supply Return.
3F, 3G	TEMP	Temperature Voltage Output.
4F, 4G	ST2	Self-Test for Sensor 2.
5F, 5G	ST1	Self-Test for Sensor 1.
6G, 7F	PGND	Charge Pump Supply Return.
6E, 7E	V <sub>DD</sub>	Positive Charge Pump Supply.

## TYPICAL PERFORMANCE CHARACTERISTICS

N > 1000 for all typical performance plots, unless otherwise noted.

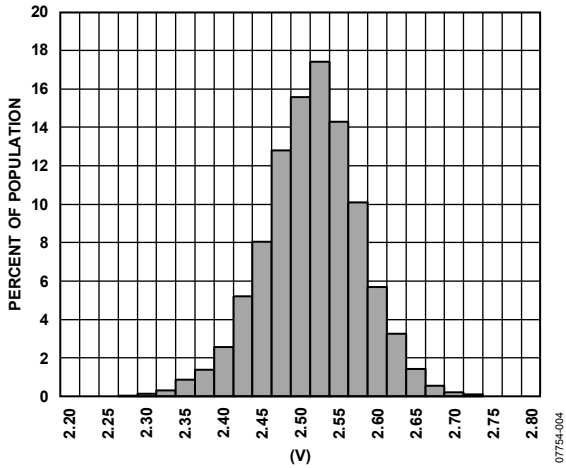

Figure 4. Null Output at 25°C ( $V_{RATIO} = 5 V$ )

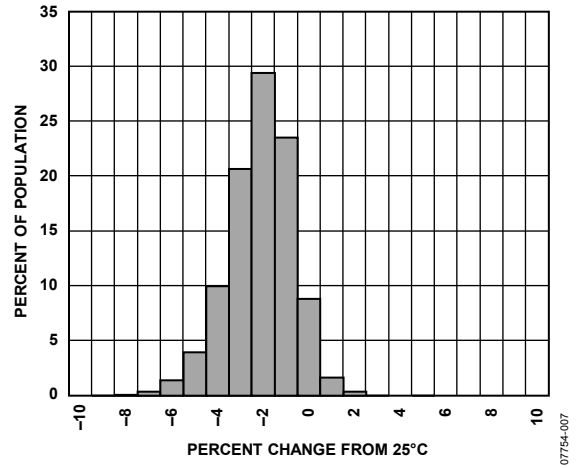

Figure 7. Sensitivity Drift over Temperature

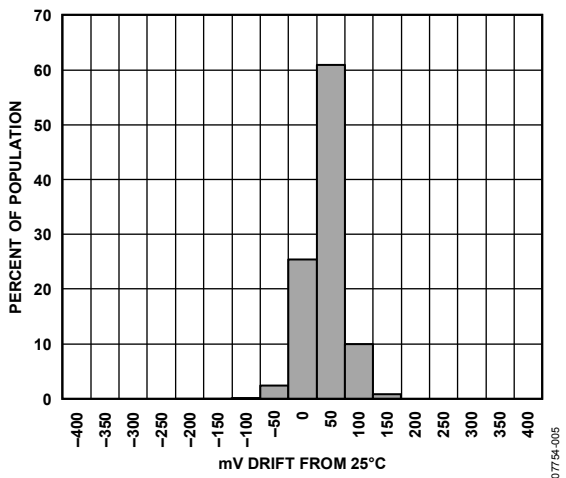

Figure 5. Null Drift over Temperature ( $V_{RATIO} = 5 V$ )

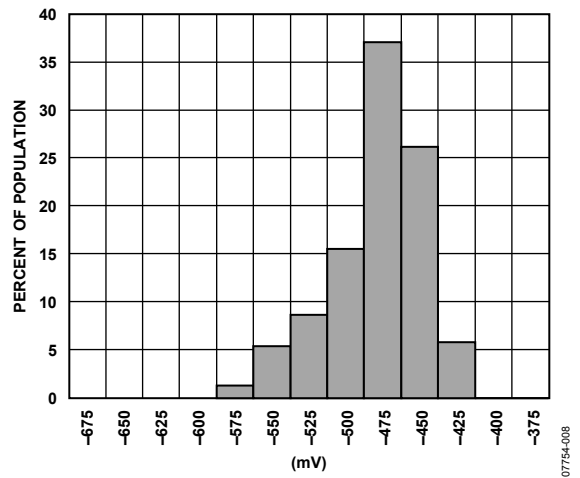

Figure 8. ST1 Output Change at 25°C ( $V_{RATIO} = 5 V$ )

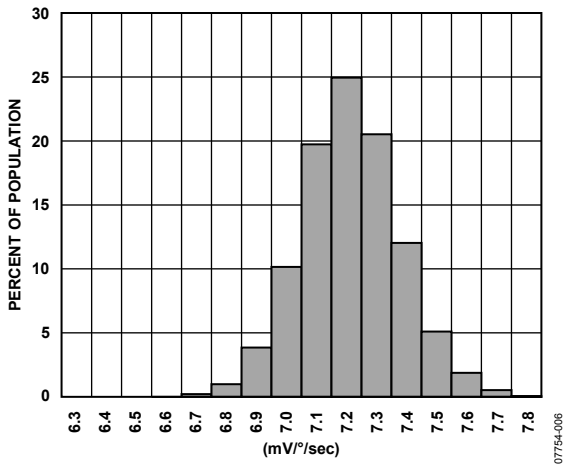

Figure 6. Sensitivity at 25°C ( $V_{RATIO} = 5 V$ )

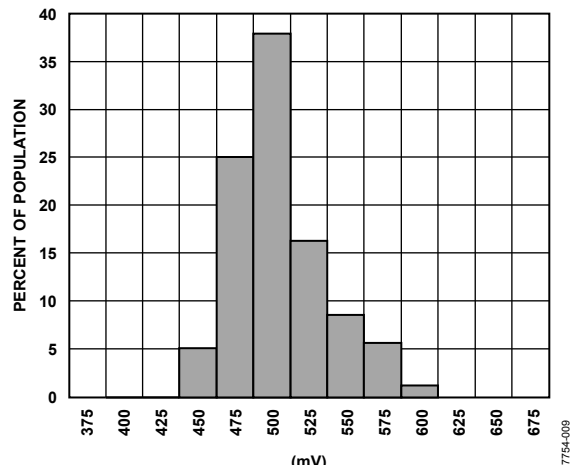

Figure 9. ST2 Output Change at 25°C ( $V_{RATIO} = 5 V$ )

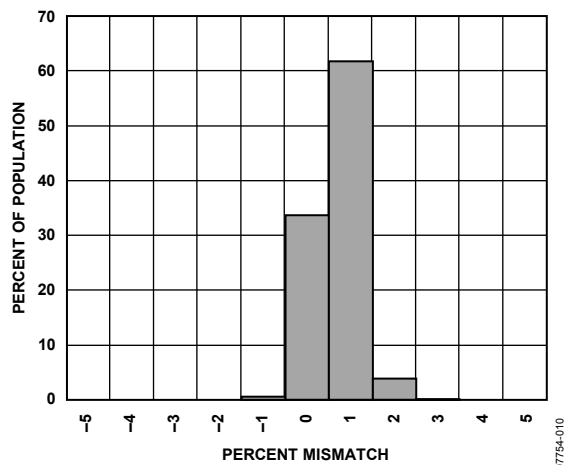

Figure 10. Self-Test Mismatch at 25°C ( $V_{RATIO} = 5 V$ )

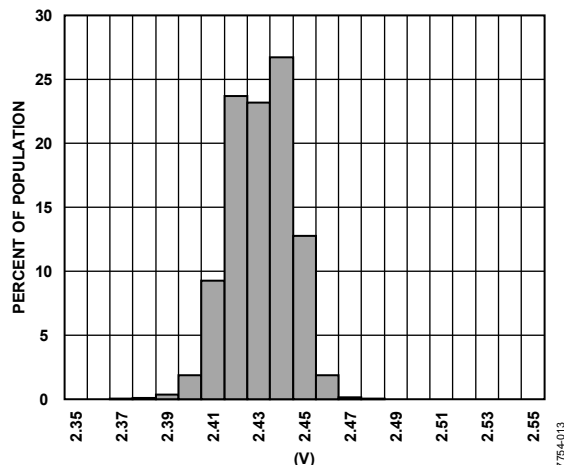

Figure 13.  $V_{TEMP}$  Output at 25°C ( $V_{RATIO} = 5 V$ )

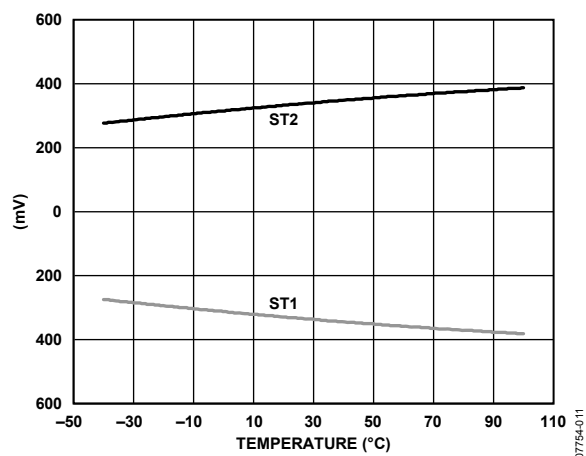

Figure 11. Typical Self-Test Change over Temperature

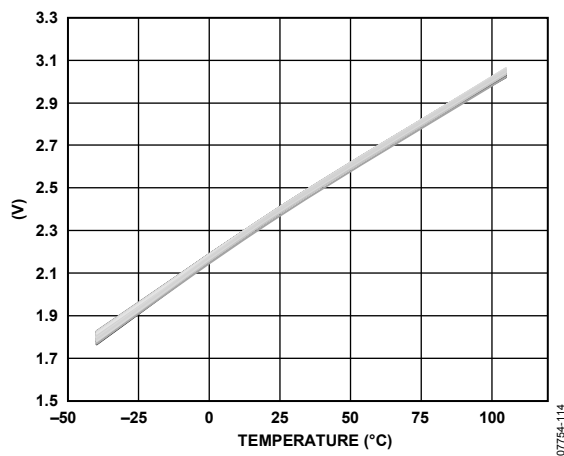

Figure 14.  $V_{TEMP}$  Output over Temperature, 256 Parts ( $V_{RATIO} = 5 V$ )

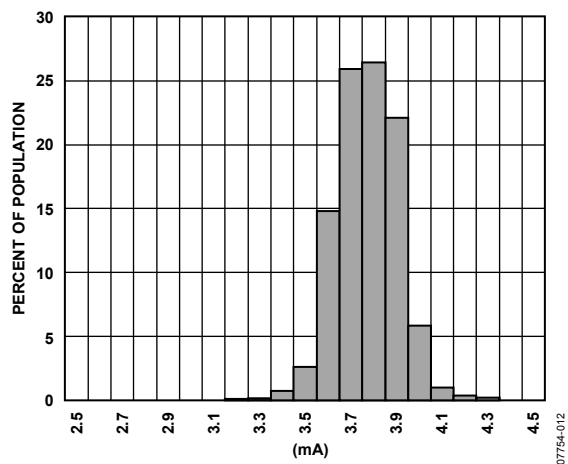

Figure 12. Current Consumption at 25°C ( $V_{RATIO} = 5 V$ )

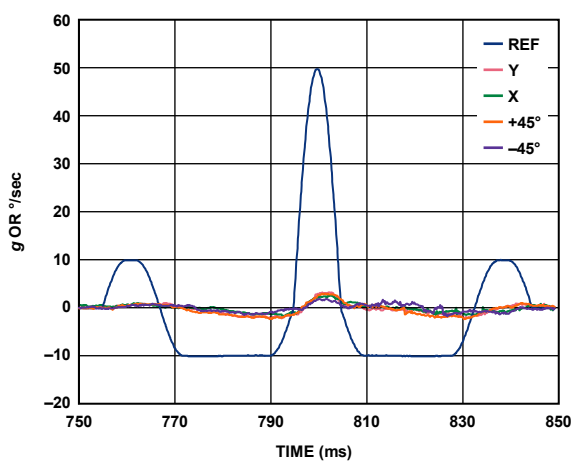

Figure 15.  $g$  and  $g \times g$  Sensitivity for a 50g, 10ms Pulse

# ADXRS622

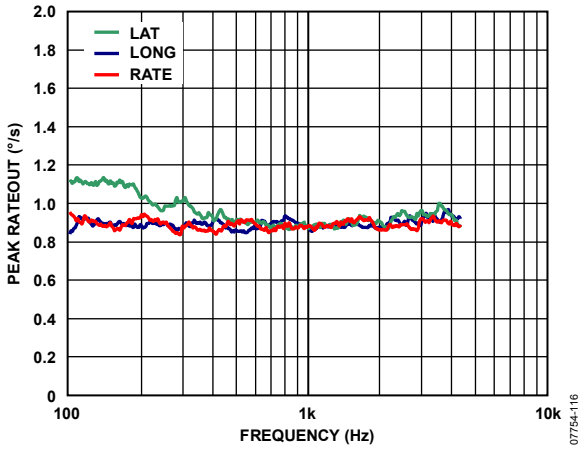

Figure 16. Typical Response to 10 g Sinusoidal Vibration (Sensor Bandwidth = 40 Hz)

07754-116

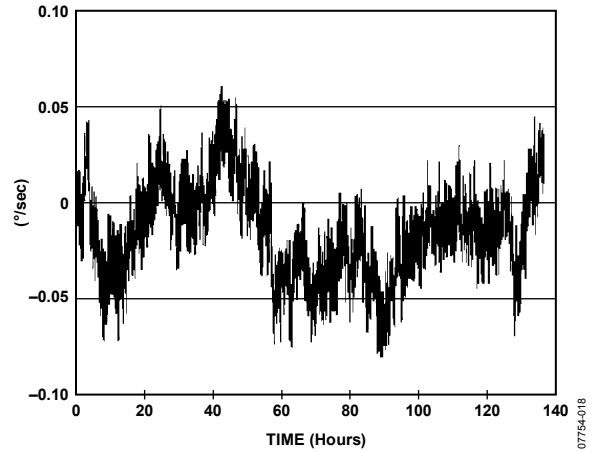

Figure 19. Typical Shift in 90 sec Null Averages Accumulated over 140 Hours

07754-018

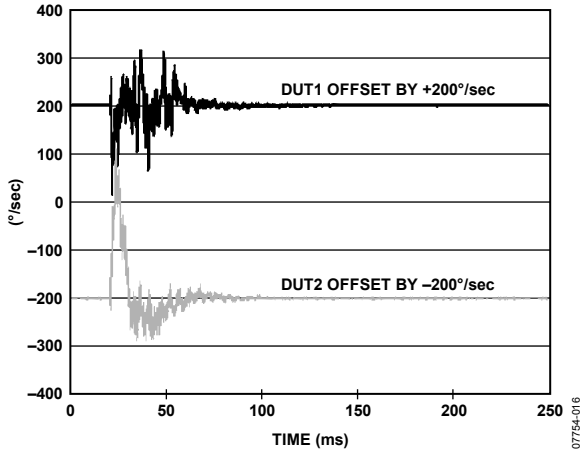

Figure 17. Typical High g (2500 g) Shock Response (Sensor Bandwidth = 40 Hz)

07754-016

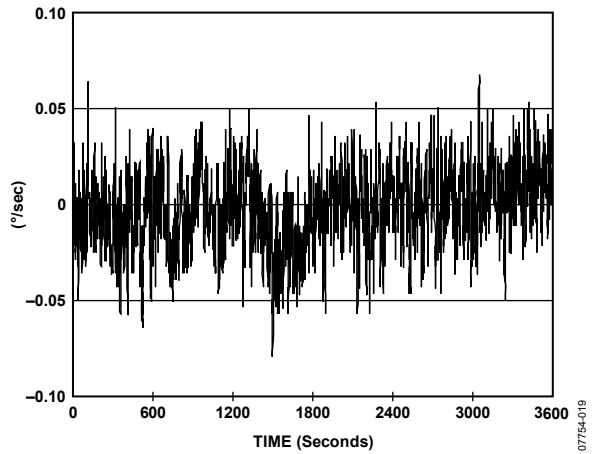

Figure 20. Typical Shift in Short Term Null (Bandwidth = 1 Hz)

07754-019

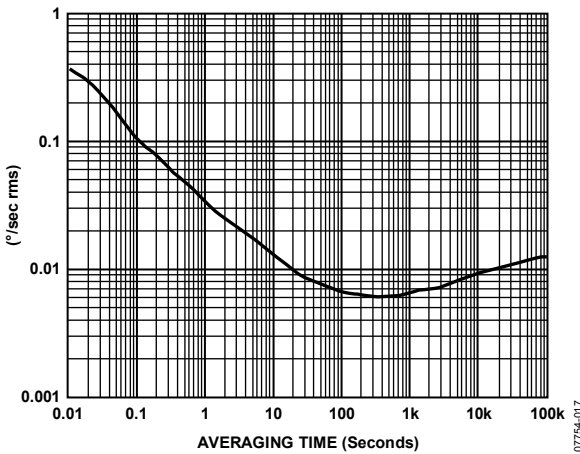

Figure 18. Typical Root Allan Deviation at 25°C vs. Averaging Time

07754-017

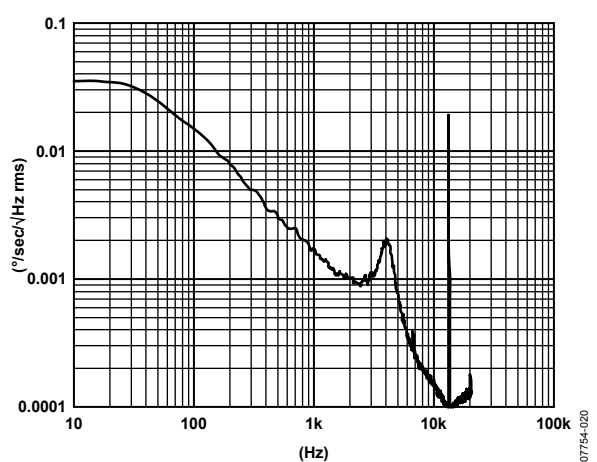

Figure 21. Typical Noise Spectral Density (Bandwidth = 40 Hz)

07754-020



## THEORY OF OPERATION

The ADXRS622 operates on the principle of a resonator gyro. Two polysilicon sensing structures each contain a dither frame that is electrostatically driven to resonance, producing the necessary velocity element to produce a Coriolis force during angular rate. At two of the outer extremes of each frame, orthogonal to the dither motion, are movable fingers that are placed between fixed pickoff fingers to form a capacitive pickoff structure that senses Coriolis motion. The resulting signal is fed to a series of gain and demodulation stages that produce the electrical rate signal output. The dual-sensor design rejects external *g*-forces and vibration. Fabricating the sensor with the signal conditioning electronics preserves signal integrity in noisy environments.

The electrostatic resonator requires 18 V to 20 V for operation. Because only 5 V are typically available in most applications, a charge pump is included onchip. If an external 18 V to 20 V supply is available, the two capacitors on CP1 from CP4 can be omitted, and this supply can be connected to the CP5 pin (6D, 7D). Note that CP5 should not be grounded when power is applied to the ADXRS622. Although no damage occurs, under certain conditions the charge pump may fail to start up after the ground is removed if power is not first removed from the ADXRS622.

### SETTING BANDWIDTH

External Capacitor  $C_{OUT}$  is used in combination with the on-chip  $R_{OUT}$  resistor to create a low-pass filter to limit the bandwidth of the ADXRS622 rate response. The -3 dB frequency set by  $R_{OUT}$  and  $C_{OUT}$  is

$$f_{OUT} = 1 / (2 \times \pi \times R_{OUT} \times C_{OUT})$$

and can be well controlled because  $R_{OUT}$  has been trimmed during manufacturing to be  $180 \text{ k}\Omega \pm 1\%$ . Any external resistor applied between the RATEOUT pin (1B, 2A) and SUMJ pin (1C, 2C) results in

$$R_{OUT} = (180 \text{ k}\Omega \times R_{EXT}) / (180 \text{ k}\Omega + R_{EXT})$$

In general, an additional hardware or software filter is added to attenuate high frequency noise arising from demodulation spikes at the 14 kHz resonant frequency of the gyro. The noise spikes at 14 kHz can be clearly seen in the power spectral density curve, shown in Figure 21. Typically, this additional filter corner frequency is set to greater than  $5 \times$  the required bandwidth to preserve good phase response.

Figure 22 shows the effect of adding a 250 Hz filter to the output of an ADXRS622 set to 40 Hz bandwidth (as shown in Figure 21). High frequency demodulation artifacts are attenuated by approximately 18 dB.

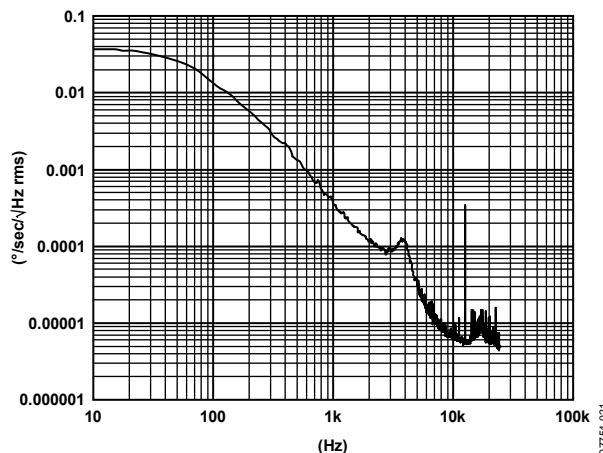

Figure 22. Noise Spectral Density with Additional 250 Hz Filter

### TEMPERATURE OUTPUT AND CALIBRATION

It is common practice to temperature-calibrate gyros to improve their overall accuracy. The ADXRS622 has a temperature proportional voltage output that provides input to such a calibration method. The temperature sensor structure is shown in Figure 23. The temperature output is characteristically nonlinear, and any load resistance connected to the TEMP output results in decreasing the TEMP output and its temperature coefficient. Therefore, buffering the output is recommended.

The voltage at the TEMP pin (3F, 3G) is nominally 2.5 V at 25°C, and  $V_{RATIO} = 5 \text{ V}$ . The temperature coefficient is  $\sim 9 \text{ mV}/^\circ\text{C}$  at 25°C. Although the TEMP output is highly repeatable, it has only modest absolute accuracy.

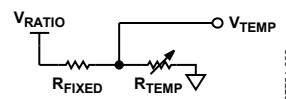

Figure 23. ADXRS622 Temperature Sensor Structure

### CALIBRATED PERFORMANCE

Using a three-point calibration technique, it is possible to calibrate the ADXRS622 null and sensitivity drift to an overall accuracy of nearly 200°/hour. An overall accuracy of 40°/hour or better is possible using more points.

Limiting the bandwidth of the device reduces the flat-band noise during the calibration process, improving the measurement accuracy at each calibration point.

# ADXRS622

## ADXRS622 AND SUPPLY RATIOMETRICITY

The ADXRS622 RATEOUT and TEMP signals are ratiometric to the  $V_{RATIO}$  voltage, that is, the null voltage, rate sensitivity, and temperature outputs are proportional to  $V_{RATIO}$ . Therefore, the ADXRS622 is most easily used with a supply-ratiometric analog-to-digital converter (ADC) that results in self-cancellation of errors due to minor supply variations.

There is some small error due to nonratiometric behavior. Typical ratiometricity error for null, sensitivity, self-test, and temperature output is outlined in Table 4.

Note that  $V_{RATIO}$  must never be greater than  $AV_{CC}$ .

**Table 4. Ratiometricity Error for Various Parameters**

Parameter	$V_S = V_{RATIO} = 4.85\text{ V}$	$V_S = V_{RATIO} = 5.15\text{ V}$
ST1		
Mean	0.3%	0.09%
Sigma	0.21%	0.19%
ST2		
Mean	-0.15%	-0.2%
Sigma	0.22%	0.2%
Null		
Mean	-0.3%	-0.05%
Sigma	0.2%	0.08%
Sensitivity		
Mean	0.003%	-0.25%
Sigma	0.06%	0.06%
$V_{TEMP}$		
Mean	-0.2%	-0.04%
Sigma	0.05%	0.06%

## NULL ADJUSTMENT

The nominal 2.5 V null is for a symmetrical swing range at RATEOUT (1B, 2A). However, a nonsymmetrical output swing may be suitable in some applications. Null adjustment is possible by injecting a suitable current to SUMJ (1C, 2C). Note that supply disturbances may reflect some null instability. Digital supply noise should be avoided, particularly in this case.

## SELF-TEST FUNCTION

The ADXRS622 includes a self-test feature that actuates each of the sensing structures and associated electronics as if subjected to angular rate. It is activated by standard logic high levels applied to Input ST1 (5F, 5G), Input ST2 (4F, 4G), or both. ST1 causes the voltage at RATEOUT to change about -0.5 V, and ST2 causes an opposite change of +0.5 V. The self-test response follows the viscosity temperature dependence of the package atmosphere, approximately 0.25%/°C.

Activating both ST1 and ST2 simultaneously is not damaging. ST1 and ST2 are fairly closely matched ( $\pm 5\%$ ), but actuating both simultaneously may result in a small apparent null bias shift proportional to the degree of self-test mismatch.

ST1 and ST2 are activated by applying a voltage equal to  $V_{RATIO}$  to the ST1 pin and the ST2 pin. The voltage applied to ST1 and ST2 must never be greater than  $AV_{CC}$ .

## CONTINUOUS SELF-TEST

The on-chip integration of the ADXRS622 gives it higher reliability than is obtainable with any other high volume manufacturing method. In addition, it is manufactured under a mature BIMOS process that has field-proven reliability. As an additional failure detection measure, power-on self-test can be performed. However, some applications may warrant continuous self-test while sensing rate. Details outlining continuous self-test techniques are also available in the AN-768 Application Note.

### OUTLINE DIMENSIONS

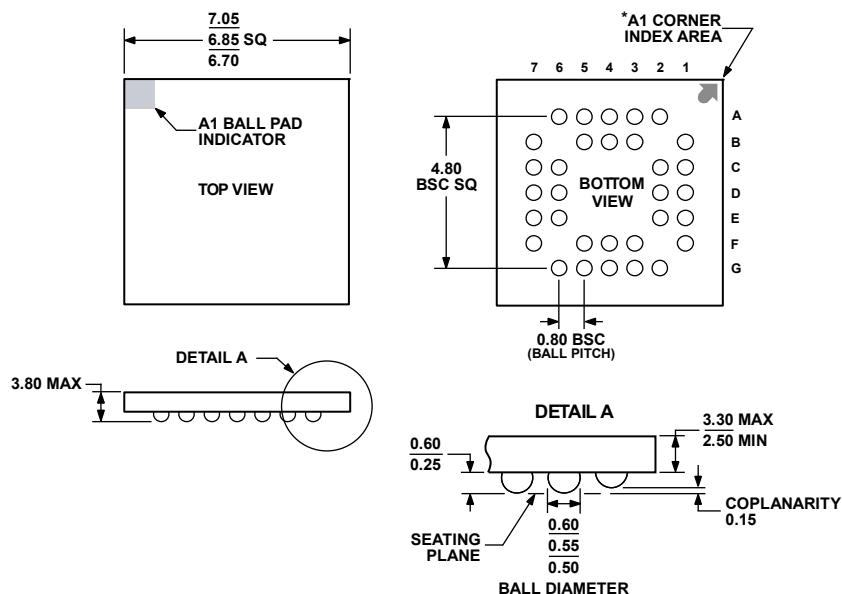

\*BALL A1 IDENTIFIER IS GOLD PLATED AND CONNECTED TO THE D/A PAD INTERNALLY VIA HOLES.

Figure 24. 32-Lead Ceramic Ball Grid Array [CBGA] (BG-32-3)

Dimensions shown in millimeters

044307-A

### ORDERING GUIDE

Model	Temperature Range	Package Description	Package Option
ADXRS622WBBGZ <sup>1</sup>	-40°C to +105°C	32-Lead Ceramic Ball Grid Array [CBGA]	BG-32-3
ADXRS622WBBGZ-RL <sup>1</sup>	-40°C to +105°C	32-Lead Ceramic Ball Grid Array [CBGA]	BG-32-3

<sup>1</sup> Z = RoHS Compliant Part.

**ADXRS622**

**NOTES**